



SEHRAWAT BROTHERS
INTERIOR AND DECORATORS PVT. LTD.

**Decor Your Space with
Luxury & Elegant**



Pine Wood

Get Free Sample Before Buy

Corporate Office

Plot No. 1, VPO - Bakkarwala, Near MCD, Girls Primary School, New Delhi - 110041, INDIA.

Toll Free No. 1800-2700-489 +91-78276-78276 +91-9555-338-248 (International Inquiry)

www.sehrawatbrothers.com sales@sehrawatbrothers.com

ALSO AVAILABLE ONLINE AT:

amazon.com snapdeal flipkart.com [SHOPCLUES.COM](http://shopclues.com) ebay paytm small be eupacasa

[MY WALL PANELS](http://mywallpanels)

[MY 3 STORE](http://my3store)

[3D Wall Panels](http://3dwallpanels)

[Lavanya Boards](http://lavanyaboards)

[Ablu](http://ably)
WPC BOARD
Stronger than wood
Use in your way

[3D Wall Panel](http://3dwallpanel)
JALI CUTTING





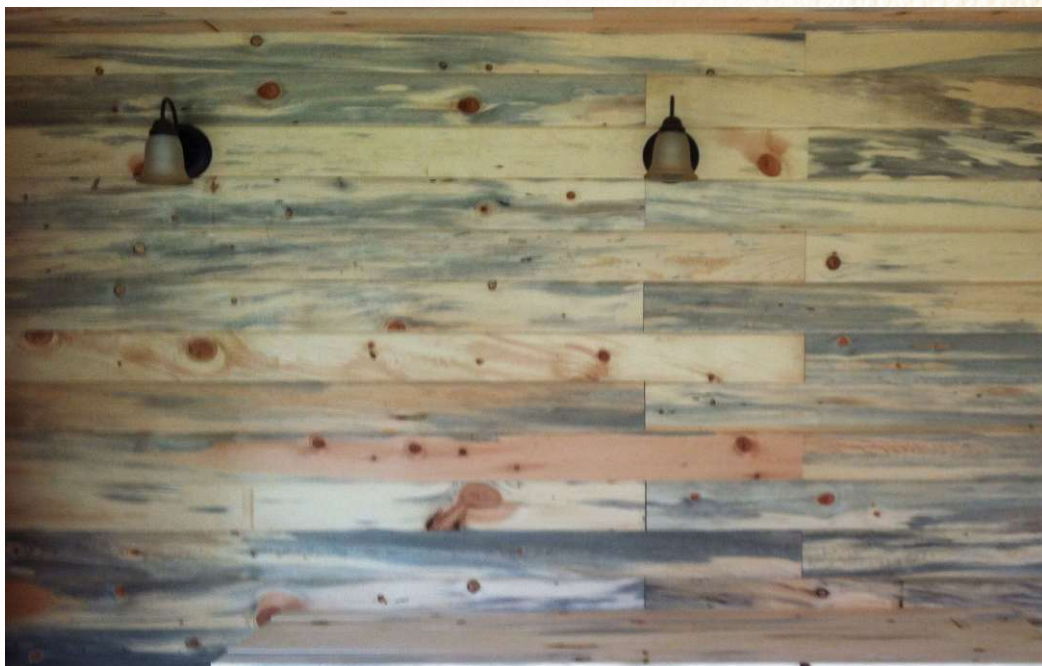

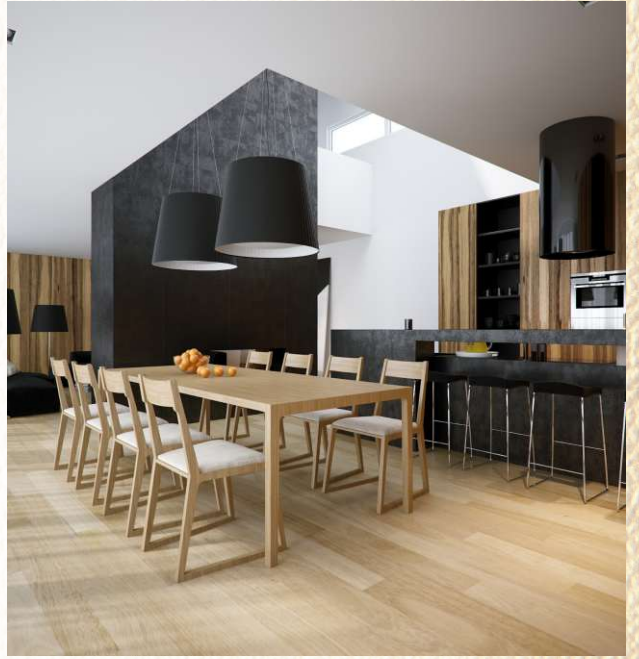
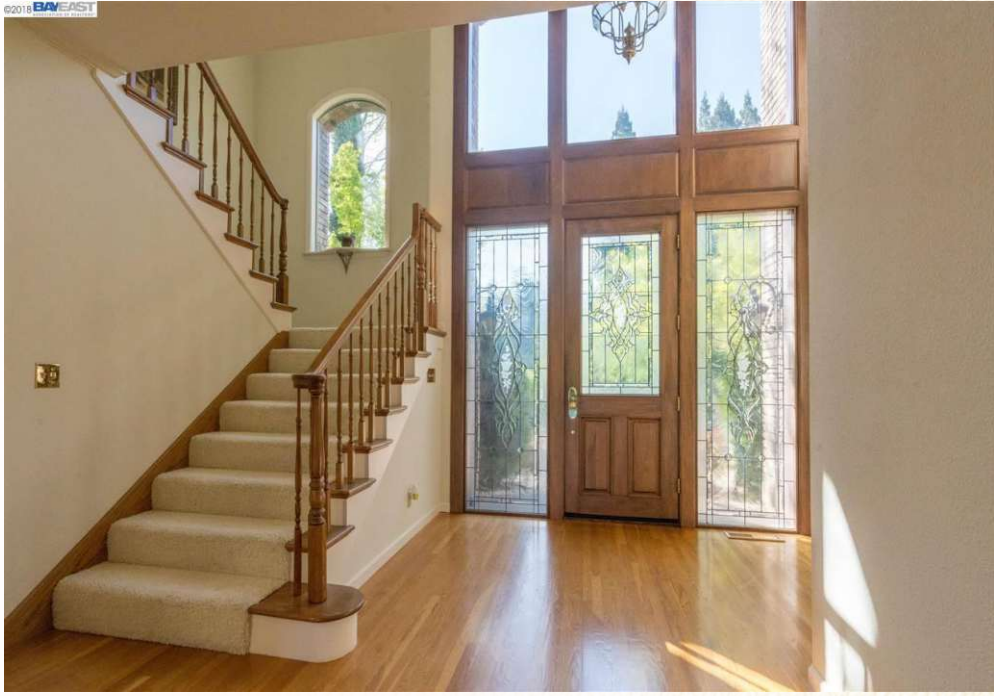



We are a trustworthy manufacturer of Southern Yellow Pine Wood for our highly esteemed clients. Best quality wood is processed using top notch machinery at our unit under the vigilant eye of experts, making it suitable for use in different industries. We go through various quality inspections prior to dispatch from our unit in adherence with the global industrial standards and norms. Southern Yellow Pine Wood is hence demanded by our clients in both domestic as well as international markets. Features: Fine Finishing Smooth Surface Wide Usage Long Life

Features

Available in three standard thicknesses: .125" .280" .410"
 Customized thicknesses ranging from .075" to .562" can also be provided.
 SmartSawn products are available in all domestic species offered by Hardwood Solutions. Components as wide as 10" can be provided.
 Available in a variety of formats to maximize value to each customer application: Random or fixed lengths
 Standard NHLA Grades or Customized grades by client
 Sawn and/or profile moulded, often only requiring single face profiling

Applications

Consider SmartSawn hardwood for:
 Cabinet color chips
 Finish mouldings under .500" in thickness
 Drawer components
 Cabinet Toe Kick
 Engineered flooring solid hardwood lamella
 Window and door skins

Installation of Pine Wood Panel

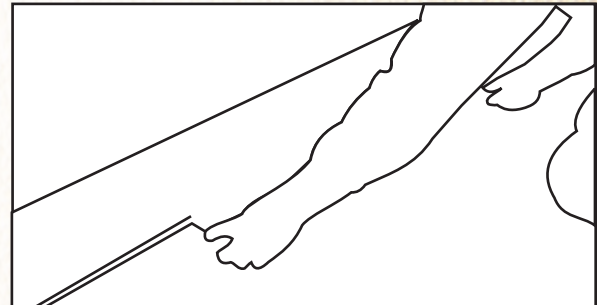
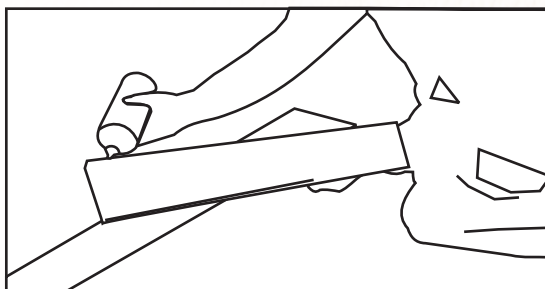
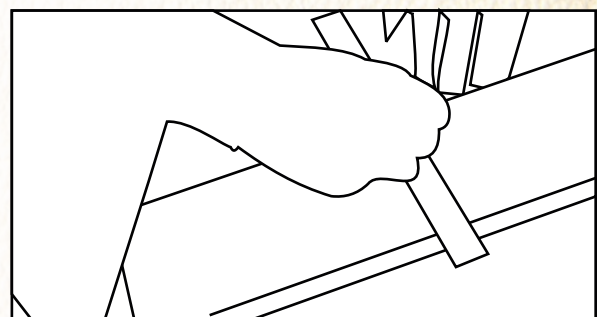
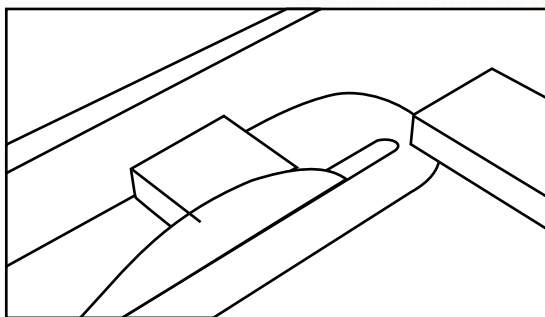

Ready to finish or assemble with as little as .010" sanding

www.sehrawatbrothers.com sales@sehrawatbrothers.com

+91-9015-130-130

